

DIY Patchwork Bird Marker Organizer Wall Hanging – Complete Step-by-Step Tutorial

Quilted Bird Wall Organizer

Step-by-Step Tutorial

This charming quilted bird has three pockets to hold small items and adds a cozy handmade touch to your space. Perfect for using fabric scraps!

MATERIALS

- Assorted quilting cotton (scraps)
- Fusible wadding (batting)
- Cotton fabric for backing
- Embroidery floss (for hand quilting)
- 1 button for eye (1.5 cm)
- Fabric glue (optional)
- Hanging cord or twine (15 cm)
- Basic sewing supplies

TOOLS

- Sewing machine
- Hand sewing needle
- Scissors / Rotary cutter
- Cutting mat & ruler
- Iron & ironing board
- Pins / Fabric clips
- Chalk pencil or fabric marker



FINISHED SIZE

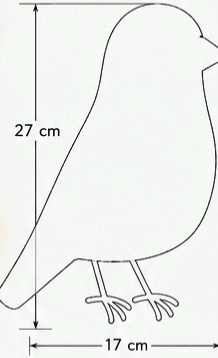

FABRIC & CUTTING GUIDE (All measurements include 0.7 cm seam allowance)

A Head Top (Rust)	1 pc	8.5 x 6 cm
B Head Back (Brown)	1 pc	6 x 7 cm
C Face (Cream)	1 pc	6 x 6 cm
D Beak (Dark Grey)	2 pcs	4 x 3 cm (each)
E Neck Stripe (Light Grey)	1 pc	4 x 3 cm
F Upper Body (Cream)	1 pc	10.5 x 7 cm
G Pocket 1 (Green)	1 pc	6.5 x 5 cm
H Pocket 2 (Mustard)	1 pc	7.5 x 5.5 cm
I Pocket 3 (Blue-Green)	1 pc	8 x 5.5 cm
J Wing Top (Green)	1 pc	9 x 5 cm
K Wing Patchwork Pieces	4 pcs	5 x 4 cm (each)
L Wing Feathers (Blue tones)	4 pcs	3 x 8 cm (each)
M Tail (Blue)	2 pcs	4 x 11 cm (each)
N Legs & Feet (Black)	2 sets	
O Backing (Full bird)	1 pc	27 x 17 cm
P Fusible Wadding	1 pc	27 x 17 cm

Note: You may adjust colors and prints as you like!

STEP-BY-STEP INSTRUCTIONS

1. PREPARE & CUT

Iron all fabrics. Cut pieces according to the guide on the right.



2. SEW THE POCKETS

- Fold the top edge of each pocket (G, H, I) 0.7 cm to the wrong side, press, then fold again 0.7 cm and topstitch.
- Place pockets on the body (F) as shown and pin.



3. MAKE THE WING

- Sew K patchwork pieces together in a row.
- Add J on top.
- Sew L feather pieces below the patchwork row.
- Sew wing to the left side of the body.



4. SEW THE HEAD

- Sew A (top) to B (back).
- Add C (face) to the front.
- Attach D (beak) between A and C.
- Add E (neck stripe) between head and body.
- Sew on button eye.

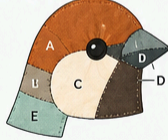

5. ASSEMBLE THE FRONT

- Sew head to body.
- Sew the wing to the body.
- Add the tail (M) to the lower back.
- Sew the legs & feet (N) to the bottom.



6. BACKING & QUILTING

- Place backing (O) right side down.
- Add fusible wadding (P) on top.
- Place front on top (right side up). Baste all layers together.
- Quilt as desired around pieces and pockets.

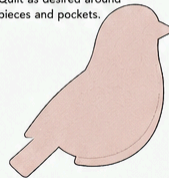

7. TRIM & BIND

- Trim around the bird shape, leaving 0.5 cm from the edge.
- Bind the edge using double fold binding (3 cm wide).
- Hand stitch or machine stitch the binding in place.

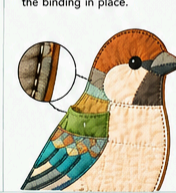

8. ADD HANGER

- Attach hanging cord (15 cm) at the top back of the bird. Secure well with stitches. Your bird organizer is ready!



BASIC SEWING & QUILTING METHODS USED

SEAM ALLOWANCE

Standard 0.7 cm (1/4 inch)

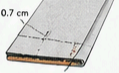

STRAIGHT STITCH

Use for piecing fabric together.

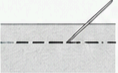

TOPSTITCHING

Sew along the edge for a neat finish.

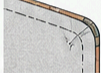

HAND QUILTING

Use a running stitch for a handmade quilted look.



APPLIQUÉ

Sew pieces onto the base fabric with small stitches.



BINDING

Encases the raw edge for a clean and durable finish.



BACKSTITCH

Use for attaching details like legs and facial features.



TIPS

- Use contrasting thread for visible quilting.
- Press your pieces as you go for best results.
- Small stitches make your work strong and neat.
- Feel free to customize colors and fabrics!

CARE INSTRUCTIONS



Enjoy your handmade bird organizer!
Happy Sewing! ❤️

This is a detailed, beginner-to-intermediate sewing tutorial based exactly on the provided pattern image. The finished bird measures **18 inches (45.7 cm) tall × 12 inches (30.5 cm) wide**. Every measurement, color, fabric type, and technique matches the labels, legend, and visual diagram (including dashed seam lines, piping, and quilting stitches). Follow the order exactly and you will be able to recreate the exact piece.

Materials (exact colors & quantities needed)

Use the **LEGEND & KEY** from the image:

1. Rich Burgundy Red cotton
2. Deep Navy Blue cotton
3. Natural Flax Linen cotton
4. Olive Green Melange cotton
5. Golden-Yellow Check cotton
6. Medium Blue Denim-like cotton
7. Chocolate Brown Stripe cotton (cut on the diagonal as shown for Patch I)
8. Warm Brown Felt (Beak, Eye surround if needed, Tail feathers O & P, Legs Q)
9. Dark Felt (Eye pupil + Beak tip)
 - Extra: Self-fabric (any of the above or matching linen) for Hanging Loop
 - Piping (bias tape or self-made) – approximately 60 inches (152 cm) total: use for all “Finished Edges” and “Curved Pocket Edge”
 - Quilting thread (any neutral or matching color)
 - Regular sewing thread to match each fabric
 - ¼-inch (6 mm) seam allowance on ALL cotton pieces unless noted
 - Basic tools: rotary cutter, ruler, pins, iron, sewing machine (or hand-sew), zipper foot for piping

Note on seam allowance: The measurements in the image are **finished patch sizes**. When cutting cotton, add ¼" (6 mm) all around. Felt pieces have NO seam allowance (they are appliquéd or top-stitched).

Step 1: Cut EVERY Piece (exact sizes & colors from the diagram)

Cut and label each piece with its letter. Use the color blocks and numbers shown directly on the image.

BIRD WALL POCKET ORGANIZER

PROFESSIONAL PATTERN – EACH PIECE

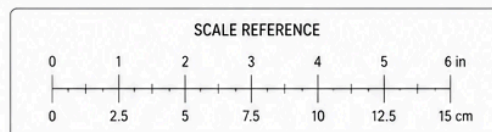
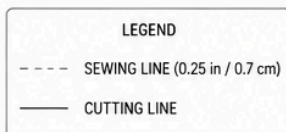
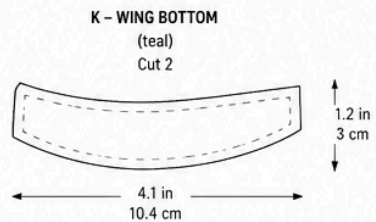
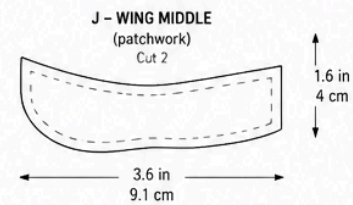
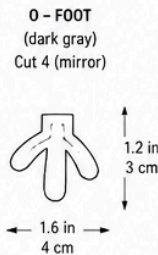
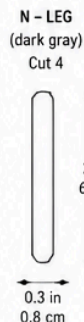
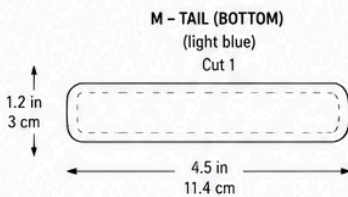
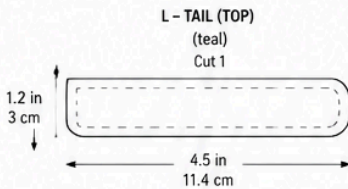
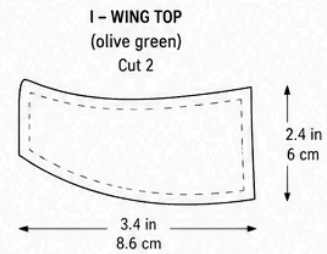
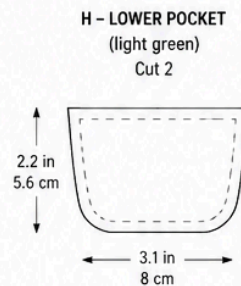
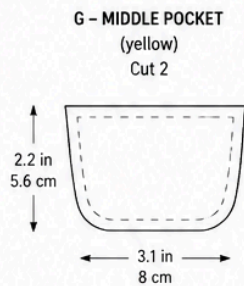
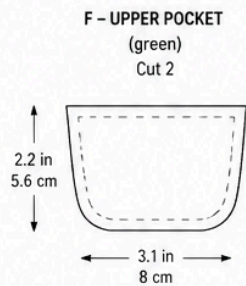
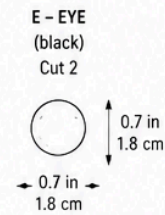
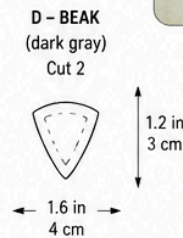
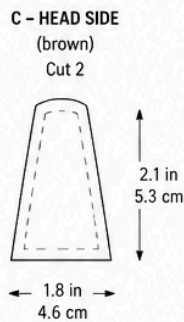
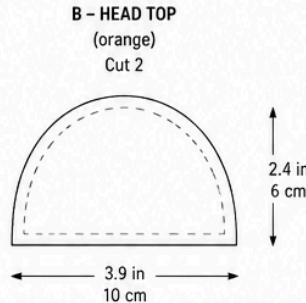
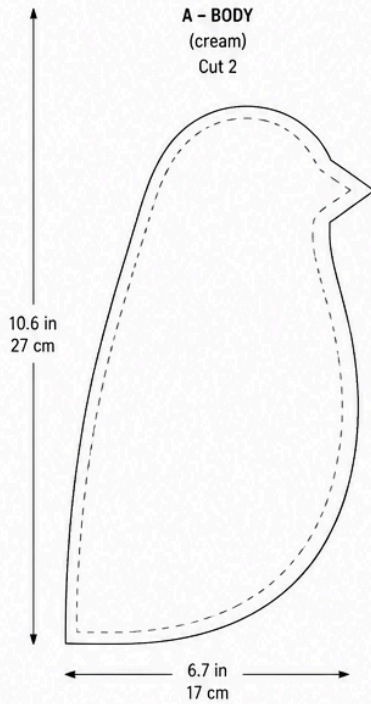

NOTE: All seam allowances are 0.25 in (0.7 cm) unless otherwise specified.

Main Body Patchwork Pieces (cotton):

- A – Color 1, 2" × 1.5" (5.1 × 3.8 cm)
- B – Color 3, 2.5" × 2.5" (6.35 × 6.35 cm) – Eye Patch area
- D – Color 8 Warm Brown, width shown 3.35 cm (≈1.32"), height follows diagram shape (nape)
- F – Color 1, 3.5" × 2.5" (8.9 × 6.35 cm) – Upper Chest
- G – Color 3, 3" × 2" (7.6 × 5.1 cm) – Upper Mid-Body
- H – Color 4, 4" × 3" (10.2 × 7.6 cm) – Upper wing area
- I – Color 7 Chocolate Brown Stripe, 4" × 3" (10.2 × 7.6 cm) – Lower Wing (stripe direction diagonal as marked)
- K – Color 6, 3.5" × ? (follow diagram) – Belly
- L – Color 5 Golden-Yellow Check, 3" × 2" (7.6 × 5.1 cm) – part of yellow pocket base area
- M – Color 3, 3" × 2" (7.6 × 5.1 cm) – Belly bottom
- N – Color 6, 2.5" × 1" (6.35 × 2.5 cm) – Tail base (The navy blue neck/chest side piece labeled "2" uses Color 2 – size follows the 2.5" vertical arrows shown.)

Pockets (cut separately – these go on top of the assembled body):

- Blue Pocket (Color 6) – rectangle large enough to cover lower body area shown (use the 3.5" × 2.5" guide for finished pocket size) – will hold Marker 3 & 4 (5" long each)
- Yellow Pocket (Color 5 Golden-Yellow Check) – rectangle with curved top edge as shown, finished size 4" × 3" area – holds Marker 2 (5" L) and Stick 1 (5.5" L)
- Olive Wing Pocket (Color 4) – rectangle 5.5" long as labeled – holds Marker 5

Felt Appliqué Pieces (no seam allowance):

- Beak (E) – Color 8 Warm Brown Felt, triangular shape as shown + tiny tip Color 9 Dark Felt
- Eye pupil – Color 9 Dark Felt, small circle/oval
- Legs (Q) – Color 8, two legs each 3" tall with feet
- Tail feathers (O & P) – Color 8, two feathers each 5" × 1" (12.7 × 2.5 cm)

Hanging Loop – Self-fabric strip: cut 4" × 2" (10.2 × 5.1 cm) to make a finished 1" long loop after folding.

Step 2: Assemble the Main Bird Body (patchwork)

Work section by section following the dashed seam lines in the image. Use ¼" seam allowance. Press all seams open.

1. **Head section:** Sew A (burgundy) to the navy blue piece (Color 2), then attach B (linen eye patch) and D (warm brown nape).
2. **Upper body:** Attach the head unit to F (burgundy upper chest).
3. **Mid-body & wing:** Sew G (linen) to H (olive green), then attach the striped I (Color 7) on the lower wing.
4. **Lower body:** Sew K (blue belly), L, M (linen belly bottom), and N (tail base) together.
5. Join the upper half to the lower half along the horizontal 2.5" seam lines shown.
6. The entire bird outline should now measure exactly 18" tall × 12" wide.

Step 3: Add Facial Features & Hanging Loop

- Appliqué the felt beak (Color 8 + tiny Color 9 tip) onto the head with a narrow zigzag or straight stitch close to the edge.
- Sew or glue the dark felt pupil (Color 9) onto the eye patch B.
- Fold the hanging loop strip in half lengthwise, stitch the long edge, turn right side out, fold into a loop, and sew the raw ends securely to the top of the head (exactly where the arrow points).

Step 4: Make & Attach the Three Pockets (most detailed part)

All pockets are top-stitched onto the body after the body is complete.

Blue Pocket (lower body):

- Cut Color 6 rectangle. Hem or pipe the top edge.
- Place over the lower body area (covering J position).
- Sew side and bottom edges only (1/4" seam).
- Add two vertical dividing stitches to create slots for Marker 3 and Marker 4 (5" deep pockets).

Yellow Pocket (center body):

- Cut Color 5 rectangle with the curved top edge shown.
- Attach piping along the curved top edge (use zipper foot).
- Place on the body exactly as shown (over the yellow area).
- Sew bottom and side edges only.
- Add one vertical dividing stitch to create two slots: one 5" for Marker 2, one 5.5" for Stick 1.

Olive Wing Pocket:

- Cut Color 4 rectangle 5.5" long.
- Hem or pipe the top edge.
- Place over the wing area (Marker 5 position).
- Sew bottom and sides only. (The small red/blue/white rectangle shown inside is just decorative fabric under the pocket – optional.)

Step 5: Add Legs & Tail Feathers

- Appliqué the two felt legs (Color 8, 3" tall) at the bottom center, stitching all around.
- Layer and appliqué the two tail feathers O & P (Color 8, 5" × 1") at the tail position, overlapping slightly.

Step 6: Finish All Edges with Piping

- Sew piping around the entire outer edge of the bird (use zipper foot).
- Also pipe any remaining "Finished Edges" and "Pocket Seam" as shown in the diagram.

Step 7: Quilting Stitch (final touch)

- Machine or hand quilt along all major seam lines and around the pockets (exactly as the arrow labeled “Quilting Stitch” shows). This gives the bird its quilted texture and holds everything flat.

Step 8: Final Press & Hang

- Give the entire piece a good press from the back.
- Insert your markers/pens into the pockets to test (the lengths match exactly: 5" and 5.5").
- Hang using the loop at the top.

You now have the exact same bird as in the image — fully functional as a marker holder and beautiful wall art!